



User Manual - Hardware

TEM Scan Controller

External scan controller for TEM, based on our
Digital Imaging Scanning System (DISS6)

User Manual

Version: 1.0

Date of Issue: 25.01.2024

Important Anybody working with TEM Scan Controller Hardware has to have read and understood the relevant parts of this manual.

Accessibility All staff working with TEM Scan Controller Hardware have to have constant access to the manual to prevent handling errors and guarantee trouble-free operation.

Reproduction All information in this document is protected by copyright. This document must not be copied, distributed or changed in any way by anyone including business units or departments of point electronic GmbH without prior written approval by point electronic GmbH. Reproduction and use of this document are confined to internal purposes of the operator only.

Notice Every endeavor has been made to make sure that the information contained in this document is complete and correct at the printing date. This manual describes all units and functions known of at the current point of time.

Contact information point electronic GmbH
Erich-Neuß-Weg 15
06120 Halle (Saale)
Germany

Phone: +49 345 1201190
Email: info@pointelectronic.de
Web: www.pointelectronic.de

Product information Product: TEM Scan Controller (DISS6)
Denomination: PE-TEM-SCAN-CONTROLLER
Manufacturer: point electronic GmbH

Table of Contents

I	Introduction	4
	User Groups of this Manual	5
	Structure of this Manual	6
	Representations in this Manual	7
	Identification of the Warning Notices	9
S	Safety Regulations	10
	Introduction	11
	Basic Hazards	12
	Staff and Qualifications	13
	Responsibility of the Operating Company	14
	Working in a Safety-conscious Manner	15
	Modifications and Alterations	16
	Maintenance Work	17
	Cleaning	19
	Environmental Protection	20
1	System Overview	21
	Intended Use	22
	Improper Use	23
	Scope of Delivery	24
	Optional Equipment	25
	System Requirements	26
	Structure	27
2	Installation and Configuration	30
	Positioning	31
	Installation	32
	Configuration of Inputs and Outputs	35
3	Maintenance	37
	Replacement of Fuses	38
4	Specifications	40
	Operating Conditions	41
	TEM Scan Controller Hardware Specifications	42

I Introduction

Chapter Overview

Purpose This chapter contains information to simplify working with this manual.

Contents This chapter contains the following topics:

- › User Groups of this Manual 5
- › Structure of this Manual 6
- › Representations in this Manual 7
- › Identification of the Warning Notices 9

User Groups of this Manual

Operators "Operators" are persons with right of disposal over TEM Scan Controller Hardware who use TEM Scan Controller Hardware for acquisition or other purposes.

Technical staff "Technical staff" are those persons that the operators entrust with tasks related to use and operation. Technical staff are trained by the operators to carry out their assigned tasks and are informed on the potential hazards that may arise due to improper handling.

Technical staff need to undergo a training by point electronic GmbH or a partner company of point electronic GmbH covering the following topics:

- handling of the connected TEM
- areas of application of TEM Scan Controller Hardware
- handling of TEM Scan Controller Hardware
- handling of DISS6 software
- basic maintenance tasks and troubleshooting

Service technicians "Service technicians" are staff members whose specialist training, knowledge and experience as well as familiarity with the relevant safety regulations mean they are able to assess the tasks they have been entrusted with and anticipate potential hazards.

Service technicians may be:

- staff members of point electronic GmbH
- staff members of partner companies of point electronic GmbH

Structure of this Manual

- Purpose** This manual describes structure, installation and maintenance of TEM Scan Controller Hardware.
- Structure** This manual is structured into chapters which are organized by technical aspects.
- Numbering** The chapters are numbered with Arabic numerals. Chapters may be structured in sections. Sections are numbered as second numbering level (e.g. 3.1). Sections are used to structure large chapters into sub-chapters.
- All pages in this manual are numbered consecutively.
- Overviews** All chapters and sections comprise an overview including content information and page numbers. This enables users to directly get acquainted with specific topics as well as using single chapters independently.
- Related information** Related cross-page information within the manual is marked with "Continuation next page ..." resp. "Continuation:". Please pay attention to the completeness of the information when copying parts of the manual.
- Cross references** The content of this manual is structured by topics. If further information on one topic may be found elsewhere in the manual, the particular chapter and page are pointed out.



Representations in this Manual

Illustrations Illustrations used in this manual do not always contain all details or special cases. They only represent the relevant information.

Menu functions In this manual, the various menu functions are presented as follows:

Finding a menu point: Open > File

Keyboard shortcuts Frequently used functions and instructions may be activated by using certain key combinations. These are presented as follows:

Keyboard shortcut	Representation
Key	
Key combination	 + 

Inputs and outputs Certain recurring symbols or descriptions are used to symbolize possible screen inputs and outputs. These are used as follows:







Inputs and outputs	Representation
Buttons	Button
Dialog windows	Dialog window
Elements of the user interface	GUI element

Mouse functions The following table explains the concepts used in this manual to describe the handling of the mouse:

Concept	Explanation
Click	singular pressing of the left mouse button
Double-click	double pressing of the left mouse button
Right-click	singular pressing of the right mouse button
Pressed mouse button	left or right mouse button is kept pressed during a process
Drag & Drop	<p>“Drag & Drop”</p> <p>Clicking on an element of the user interface, dragging the element with pressed mouse button to another position, dropping the element in this position.</p>

Continuation next page ...

Icons The following icons are used to visually emphasize certain information:

Icon	Meaning
	Notice For example:  The selected parameter will not be inserted in the parameter list.
	Reference to another part of this manual For example:  see „Cross references“ on page 6
	Use of a specific tool For example:  screwdriver TX 10



Notices Important notices are marked as follows:

NOTICE	Please always mind the notices marked in this manual!
	Notices explain relations that even for expert users might not be evident at first glance. The neglect of a notice is no direct security risk. However, it can lead to disturbances in the operating procedure.

Identification of the Warning Notices

Purpose This operating manual includes warning notices that may lead to serious consequences if disregarded. Warning notices are not only listed in the "Safety Regulations" chapter, but especially in places where hazards for people, equipment and operation may arise.

Identification of hazards There are three classes of hazards. These classes are indicated by specific signal words and colors. They include the following:

Signal word	Meaning
 DANGER	Warning notice, which if disregarded will definitely or very likely result in death or very serious injury.
 WARNING	Warning notice, which if disregarded may result in serious injury, permanent damage to health or serious property loss.
 CAUTION	Warning notice, which if disregarded may result in injury or property loss including financial losses due to operational impairment.

S Safety Regulations

Chapter Overview

Purpose This chapter contains safety information relating to the protection of persons as well as safe and fault-free operation. All user groups of the hardware and software must be aware of and follow these safety provisions.

Contents This chapter contains the following topics:

› Introduction	11
› Basic Hazards	12
› Staff and Qualifications	13
› Responsibility of the Operating Company	14
› Working in a Safety-conscious Manner	15
› Modifications and Alterations	16
› Maintenance Work	17
› Cleaning	19
› Environmental Protection	20

Introduction

Reliable and safe operation The reliable and safe operation of the TEM Scan Controller depends on carefully implementing the operating, setup and maintenance tasks.

Observance of the safety instructions Always observe and follow the safety instructions and accompanying code of conduct when handling the TEM Scan Controller hardware and software. Always point out the instructions and code of conduct to staff working with the hardware and software.

Generally applicable safety regulations (such as accident prevention and environmental protection regulations, etc.) must also be observed.

Consequences arising from failure to observe the safety instructions Failure to observe the safety instructions can result in death or serious injury of personnel and damage or destruction of the hardware components.

Basic Hazards

Definition The TEM Scan Controller Hardware meets the current state of the art as well as the applicable safety regulations. The TEM Scan Controller Hardware has been tested at the manufacturer's site and is delivered in a state safe for operation.

Basic hazards are residual risks that may arise despite proper and safety-conscious use of the TEM Scan Controller Hardware.

⚠ DANGER	<p>Risk of death by electrocution!</p> <p>Touching live parts may lead to death or serious injury.</p> <ul style="list-style-type: none"> – Turn off the mains voltage before any works on the TEM Scan Controller Hardware. – Secure the TEM Scan Controller Hardware against unintentional re-start. – Works on the TEM Scan Controller Hardware may only be executed by service technicians. – Never operate the TEM Scan Controller Hardware when the mains cable is damaged.
⚠ WARNING	<p>Risk of injury due to improper use!</p> <p>Improper use of the TEM Scan Controller Hardware may lead to injury.</p> <ul style="list-style-type: none"> – Always protect the TEM Scan Controller Hardware from extreme heat (excessive sun exposure, close proximity to open fire or heating equipment) during operation and storage. – Avoid hard impacts that might damage parts of the TEM Scan Controller Hardware.

Staff and Qualifications

Permissions Works on the TEM Scan Controller Hardware may only be performed by technical staff and/or service technicians (🔑 see „User Groups of this Manual“ on page 5).

Note the legally prescribed minimum age for personnel.

Only qualified electricians or technical staff under guidance and supervision of a qualified electrician may perform works on electrical components of the TEM Scan Controller Hardware in accordance with the electrotechnical regulations.

Staff undergoing training or instructions or persons taking part in general vocational training programs may only operate the TEM Scan Controller Hardware under the continuous supervision of technical staff.

Responsibility of the Operating Company

- Condition of the TEM Scan Controller Hardware and/or the overall system** The operating company shall ensure that all safety and protective devices are fully functional at all times. This equipment should therefore be checked periodically for functionality and completeness.
- This applies to the TEM Scan Controller Hardware as single component as well as the overall system into which TEM Scan Controller Hardware is integrated as a subcomponent.
- Internal measures to avoid hazards** The operating company must be aware of the applicable industrial safety regulations and use a risk assessment to determine any additional hazards that may arise from the special working conditions at the TEM Scan Controller Hardware's site of operation. Internal instructions for avoiding the identified hazards should then be drawn up.
- Throughout the entire operating period of the TEM Scan Controller Hardware, the operating company must examine and determine whether the supplied operating instructions comply with the current status of applicable regulations.
- Staff** Regarding the staff authorized or trained by the operating company, the operating company carries the following responsibilities:
- The necessary training and instruction of staff must be guaranteed.
 - The powers and responsibilities of staff for installation, operation, maintenance and service must be clearly defined and documented.
 - This user manual must be kept in the immediate surroundings of the TEM Scan Controller Hardware and must be readily accessible to staff.

Working in a Safety-conscious Manner

Accident prevention and environmental protection In addition to the information in this user manual, also note the generally applicable statutory and other binding regulations relating to accident prevention and environmental protection.

This may include, for example:

- dealing with hazardous substances
- wearing the necessary and prescribed personal protective clothing
- observance of and compliance with all national and regional industrial safety regulations
- observance of and compliance with all internal working, operating and safety regulations

Content of this user manual Prior to operation, all staff members assigned to work on the TEM Scan Controller Hardware must have read and understood the relevant parts of this user manual, especially the chapter "Safety Regulations".

Modifications and Alterations

No unauthorized modifications Any unauthorized modifications to the TEM Scan Controller Hardware exclude any liability by the manufacturer for resulting damage and consequences.

Do not perform any modifications, additions and/or alterations to the TEM Scan Controller Hardware without written authorization from point electronic GmbH.

Spare parts and accessories Spare parts and accessories must comply with the technical requirements specified by point electronic GmbH and its suppliers. Whenever original parts are used, compliance is given.

No modifications of the software No modifications to the software must be made or commissioned to third parties. The software may not be deleted, decrypted or decompiled in full or in part.

If changes to the software are necessary, please contact point electronic GmbH.

Maintenance Work

Implementation High reliability as well as low maintenance costs of the TEM Scan Controller Hardware may be achieved through careful implementation of the maintenance schedule and regular monitoring over the entire operational lifetime.

Compliance with regulations When performing maintenance work, it is essential to observe the following:

- applicable accident prevention regulations,
- applicable environmental protection regulations and
- safety instructions for maintenance work.

Only perform maintenance work if:

- you are authorized to do so and
- the TEM Scan Controller Hardware is turned off and secured against unintentional restart.

Before getting started Before you begin maintenance work, please make sure that:

- the TEM Scan Controller Hardware is de-energized and disconnected from the power supply and
- the power supply may not be re-established unintentionally as long as the maintenance work lasts.

Works during operation In any case, the operating company or the personnel employed by it must check based on the specific local conditions that the specified work may be performed during operation without endangering anybody.

Continuation next page ...

Electrical equipment Regularly check the electrical equipment of the TEM Scan Controller Hardware. Immediately rectify defects (such as loose cable connections and/or faulty cables).

Damaged or faulty cables may only be replaced by cables that match the requirements stipulated by point electronic GmbH and/or its suppliers!

Check that the surfaces of all electrical equipment parts are dry and free of oil, grease, deposits and corrosion.

Only use voltage-insulated tools!

Do not place any tools or working materials on the conductive surfaces of components.

Faulty fuses may only be replaced by fuses that match the requirements (specifications and ratings) stipulated by point electronic GmbH!

Faulty fuses may not be repaired or bypassed, but must be replaced by fuses of the same type.

Cleaning

- Suitable cleaning products** Only use cleaning products approved by point electronic GmbH.
- All cleaning products used by the customer should be checked with point electronic GmbH or the respective supplier to ensure they are compatible with the materials and colors used.
- Unsuitable cleaning agents** Never use aggressive cleaning agents for cleaning the TEM Scan Controller Hardware.
- Cleaning equipment** Use lint-free cleaning cloths/wipes for cleaning the TEM Scan Controller Hardware.
- After cleaning** After cleaning, make sure that:
- cables, ports and fittings are free of oil and/or cleaning agents and
 - cables, wires, connectors and electrical components are dry.

Environmental Protection

Recyclable materials When performing maintenance work, ensure that reusable materials are recycled.

Disposal Electrical and electronic waste may constitute a hazard to health and environment when disposed off improperly. According to WEEE (Waste Electrical and Electronic Equipment Directive) 2012/19/EU, electrical and electronic waste may not be disposed off as general domestic waste but must be handed in at specific collection points or sent back to the manufacturer.

Check with your local environmental protection agency for the prescribed disposal options for commercially used electronic waste.

Only hire waste disposal companies that are approved by the national and regional authorities.

1 System Overview

Chapter Overview

Purpose This chapter describes the TEm Scan Controller Hardware. It contains information on the use, scope of delivery, equipment, structure and function.

Contents This chapter contains the following topics:

› Intended Use	22
› Improper Use.	23
› Scope of Delivery	24
› Optional Equipment	25
› System Requirements	26
› Structure	27

Intended Use

Purpose The TEM Scan Controller Hardware and software are exclusively intended for the acquisition and management of digital image data.

Operation The TEM Scan Controller Hardware may only be operated in a technically perfect condition and as intended, in compliance with the user manual and under consideration of safety and potential hazards. Malfunctions, in particular those that may impair safety, should be rectified immediately.

If the TEM Scan Controller Hardware shows damages or defects that compromise operational safety, this must immediately be reported to the operations center, and the TEM Scan Controller Hardware must not be put into operation.

Operation and maintenance of the TEM Scan Controller Hardware may only be performed by technical staff and service technicians (🔧 see „User Groups of this Manual“ on page 5). The valid safety and accident prevention regulations must be observed.

Compliance with regulations All operating, maintenance, setup and service measures prescribed by the manufacturer must be complied with.

Additional information In addition to this user manual, the generally applicable, legal and other binding regulations and legislation and environmental protection instructions must be adhered to.

Improper Use

Any use not authorized by the manufacturer is not permissible and may lead to injury or property damage.

point electronic GmbH does not accept liability for damage arising from improper use of the TEM Scan Controller Hardware.

In particular, improper use includes:

- operation in explosive environments
- operation in an environment that does not meet the stipulated requirements
 -  see „Operating Conditions“ on page 41
- modifications and/or additions that impair the performance
- exchanging components with unauthorized components

Scope of Delivery

The following equipment is part of TEM Scan Controller Hardware's scope of delivery:

- mains cable
- USB cable
- set of connecting cables for scan and video
- USB stick with software, documentation and driver

Optional Equipment

The delivered equipment depends on the order details. It includes:

- EDX/WDX system
- Multi-Channel Signal Amplifier (MICS)
- Electron Beam Induced Current (EBIC) measurement system
- Electron Beam Absorbed Current/Resistive Contrast Imaging (EBAC) imaging system

System Requirements

Computer system The following table contains information on the minimum requirements of the computer system:

Component	Requirement
Computer	IBM-compatible from Core i3
Operating system	Windows 7 to 11 (x86 or x64)
RAM	8GB
Graphics	resolution at least 1280×1024 pixels, true color
Interfaces	at least one free USB 2.0 or USB 3.0 port
Periphery	mouse with scroll wheel

Structure

Front The following figure shows the front of the TEM Scan Controller Hardware with its components:

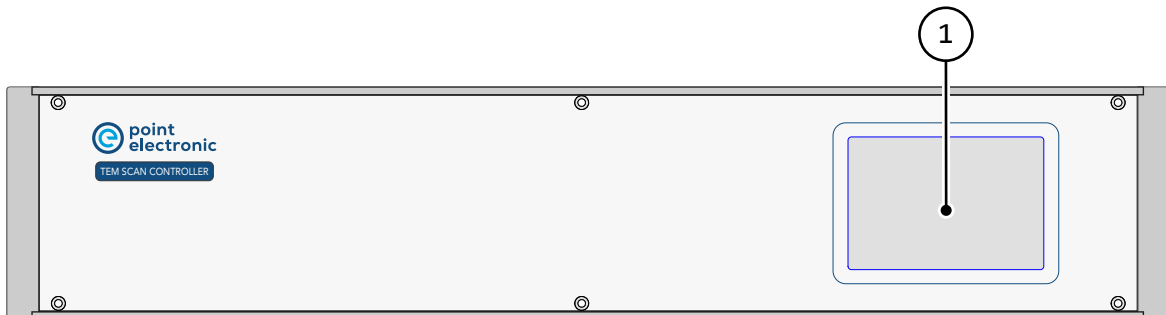

The following table contains information on the components on the front of the TEM Scan Controller Hardware:

No.	Component
1	Touch-sensitive display shows status and system information in several switchable categories

Continuation next page ...

Back The following figure shows the back of the TEM Scan Controller Hardware with its components:

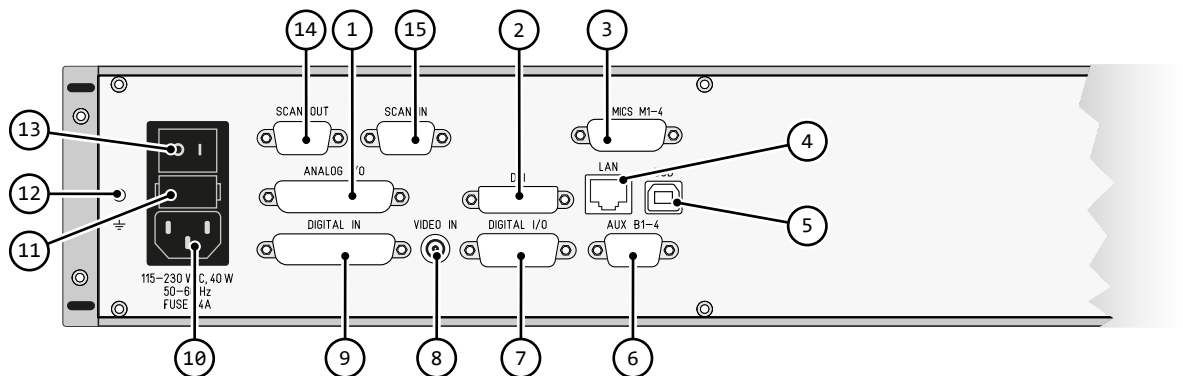

The following table contains information on the components on the back of the TEM Scan Controller Hardware:

No.	Component
1	Analog I/O – port for analog inputs and outputs – type: 25 pin D-Sub male
2	DVI – port – type: DVI-I (dual link) female
3	MICS M1-4 – port for Multi-Channel Signal Amplifier (optional) – type: 15 pin D-Sub female
4	LAN – port for network connection – type: RJ-45 socket
5	USB – USB port – type: USB type B
6	AUX B1-4 – port for additional analog inputs (fast) – type: 9 pin D-Sub male
7	Digital I/O – port for digital inputs and outputs – type: 15 pin D-Sub female

Continuation next page ...

No.	Component
8	Video In – video input for composit video (PAL) – type: cinch socket
9	Digital In – video counter inputs 1-12 (3.3V/5 V TTL) – type: 25 pin D-Sub female
10	Mains voltage connector – 115–230 VAC, 25 W, 50–60 Hz – type: C14 male
11	Fuses – 2 pieces – replaceable – type: T4A
12	Protective grounding connector
13	On/off switch
14	Scan out - differential scan output (switched to DISS6 scan if a DISS6 scan is running) - type: 9 pin D-Sub female
15	Scan in - differential scan input (switched to Scan Out if no DISS6 scan is running) - type: 9 pin D-Sub male

2 Installation and Configuration

Chapter Overview

Purpose This chapter contains information and instructions on installation and configuration of the TEM Scan Controller Hardware.

Contents This chapter contains the following topics:

- › Positioning 31
- › Installation 32
- › Configuration of Inputs and Outputs 35

Positioning

Installation site Please make sure that the installation site adheres to the stipulated operating conditions.

 see „Operating Conditions“ on page 41

Position the TEM Scan Controller Hardware on a level non-slip working surface.

NOTICE	Always ensure accessibility!
	When positioning the TEM Scan Controller Hardware, please ensure that on-off switch and all connectors are accessible without obstructions.

Installation

Requirements Prior to installation of the TEM Scan Controller Hardware, please check to make sure that the connected computer complies with the following requirements:

- The computer is equipped with a USB 2.0 or USB 3.0 port. If this is not the case, please install a USB plug-in card. Mind the system requirements for installation of the drivers.
 see „System Requirements“ on page 26
- The DISS6 software is already installed on the computer.

Before getting started Complete the following steps to prepare the installation of the TEM Scan Controller Hardware:

NOTICE	<p>Please mind the TEM Scan Controller Hardware connectors!</p> <p>When connecting the TEM Scan Controller Hardware, please refer to the description of the unit's backside.</p> <p> see „Back“ on page 28</p>
---------------	--

1. Connect the protective grounding to the TEM Scan Controller Hardware.
2. Connect the TEM Scan Controller Hardware to the supply voltage.
3. Start the computer.
4. Switch on the TEM Scan Controller Hardware.

Continuation next page ...

Steps Complete the following steps to completely install the TEM Scan Controller Hardware:

1. Use a USB cable to connect the TEM Scan Controller Hardware to the computer's USB port.
→ A dialog window with a prompt to install the driver will appear on the screen.
2. Use the automatic search to find the driver on your computer system.
3. Configure the digital outputs "ext. blank out" and "ext. scan out".
 - i** These outputs are potential-free relay outputs destined for switching the TEM to external beam control. They need to be adjusted to the TEM's requirements.
 - 📖** see „Configuration of Inputs and Outputs“ on page 35
4. Connect the TEM Scan Controller Hardware to the TEM.
 - i** Please mind the following plan of pin assignment on the following page (**📖** see page 34)
5. Optional: Establish a connection to the EDX/WDX systems.
For this, connect the impulse inputs with the counter outputs of the Wavelength Dispersive X-ray Spectrometer (WDX) and/or the output windows of the Energy Dispersive X-ray Spectrometer (EDX).
 - i** The inputs are designed for TTL levels. For differing levels, adaptation by the manufacturer is necessary.
6. Optional: Connect the TEM to the computer via RS232.

Functional test After complete installation of the TEM Scan Controller Hardware, a functional test may be carried out independent from the TEM. For this, the x and/or y deflecting voltage are assigned to the inputs for analog image signals. The image acquisition provides an optical wedge for X or Y direction.

Continuation next page ...

Scan Out
9 pin Sub-D female

1	Scan Y- Output
6	Scan Y+ Output
5	Scan X- Output
9	Scan X+ Output

differential scan output
(switched to DISS6 scan
if a DISS6 scan is run-
ning)

Scan In
9 pin Sub-D male

1	Scan Y- Input
6	Scan Y+ Input
5	Scan X- Input
9	Scan X+ Input

differential scan input
(switched to Scan Out
if no DISS6 scan is
running)

AUX B1-B4
9 pin Sub-D male

1	video B1+
6	video B1-
2	video B2+
7	video B2-
3	video B3+
8	video B3-
4	video B4+
9	video B4-
5	GND

multiplexed inputs
(A or B simultaneous)

Analog I/O
25 pin Sub-D male

1	scan y out
2	scan x out
3	ext. scan out
4	ext. blank out
5	video A1+
6	video A1-
7	video A2+
8	video A2-
9	video A3+
10	video A3-
11	video A4+
12	video A4-
14	scan y in
15	scan x in
16	ext. scan in
17	ext. blank in
18-24	GND

Scan Outputs
±12V max.

Digital I/O
15 pin Sub-D female

1	PixelClock
2	LineClock
3	FrameClock
4	HoldClock
5	Ext. Scan
6	Ext. Blank
7	BeamBlanker
8	Lock-In Ref Out
9	GND
10	GND
11	Pixel Sync
12	Line Sync
13	Frame Sync
14	Pause In
15	Spare I/O

Sync: TTL Inputs
Clock: TTL Outputs
Ext.: TTL Outputs

MICS
25 pin Sub-D female

1	In A+
2	In B+
3	In C+
4	In D+
6	GDN
6	+2.5 V supply out
7	GDN
8	+10 V detector BIAS (configurable)
9	In A-
10	In B-
11	In C-
12	In D-
13	GDN
14	-2.5 V supply out
15	GDN

BSE solid state
detector input and
supply output

Digital In
25 pin Sub-D female

1	X 1
2	X 2
3	X 3
4	X 4
5	X 5
6	X 6
7	X 7
8	X 8
9	X 9
10	X 10
11	X 11
12	X 12
14-25	GND

TTL Counter Inputs

Configuration of Inputs and Outputs

Description All inputs and outputs are adjusted to the connected TEM on the carrier board of the TEM Scan Controller Hardware.

⚠ DANGER	<p>Risk of death by electrocution!</p> <p>Body contact with live parts can lead to death or very serious injuries as well as the destruction or damaging of components.</p> <ul style="list-style-type: none"> – Prior to the configuration of inputs and outputs, please make sure that the TEM Scan Controller Hardware is de-energized and secured against unintentional starting (re-start).
-----------------	--

Before getting started Complete the following steps before configuring the inputs and outputs of the TEM Scan Controller Hardware:

1. Switch off the TEM Scan Controller Hardware.
2. Remove the mains cable.
3. Remove all connected cables from the TEM Scan Controller Hardware.

Steps Complete the following steps to configure the inputs and outputs of the TEM Scan Controller Hardware:

1. Remove the 4 screws (TORX TX 10) on the back of the TEM Scan Controller Hardware.

 screwdriver TX 10

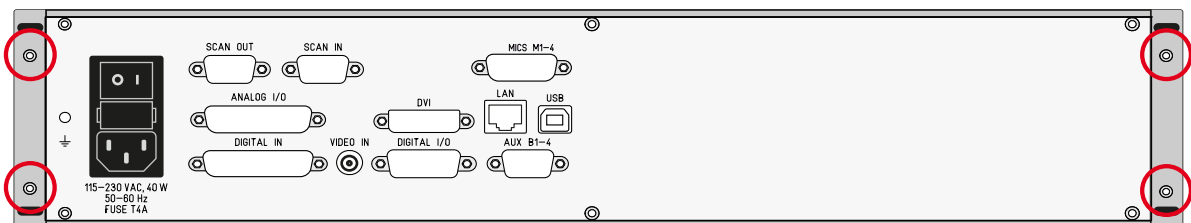

2. Push back the upper casing cover.

Continuation next page ...

3. Adjust all allocations according to the layout illustration:



K15 / K16 Configuration:

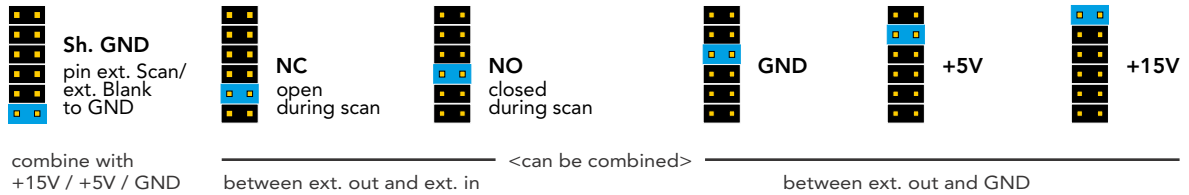

4. Configuration of the output voltage range of the differential scan outputs (Scan Out)

Without jumper „Low“
 ±2.2 V ... ±7.5 V

With jumper „Low“
 ±0.65 V ... ± 2.2 V

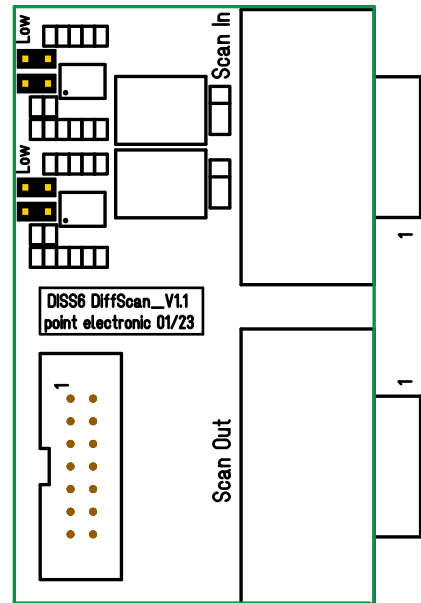

- Close the casing cover.
- Attach the 4 screws (TORX TX 10) on the back of the TEM Scan Controller unit.

screwdriver TX 10

3 Maintenance

Chapter Overview

Purpose This chapter contains instructions on the maintenance of the TEM Scan Controller Hardware.

Contents This chapter contains the following topics:

› Replacement of Fuses 38

Replacement of Fuses

Position of the fuses The fuses are located at the back of the TEM Scan Controller Hardware.

 see „Back“ on page 28

 DANGER	<p>Risk of death by electrocution!</p> <p>Body contact with live parts can lead to death or serious injuries as well as the destruction or damaging of components.</p> <ul style="list-style-type: none">– Prior to the replacement of the fuses, please make sure that the TEM Scan Controller Hardware is de-energized and secured against unintentional starting (restart).
---	---

Before getting started Complete the following steps before configuring the inputs and outputs of the TEM Scan Controller Hardware:

1. Switch off the TEM Scan Controller Hardware.
2. Remove the mains cable.
3. Remove all connected cables from the TEM Scan Controller Hardware.

Continuation next page ...

Steps Complete the following steps to replace the fuses of the TEM Scan Controller Hardware:

1. Pinch the locking tongues of the fuse holder and pull the fuse holder from the slot.

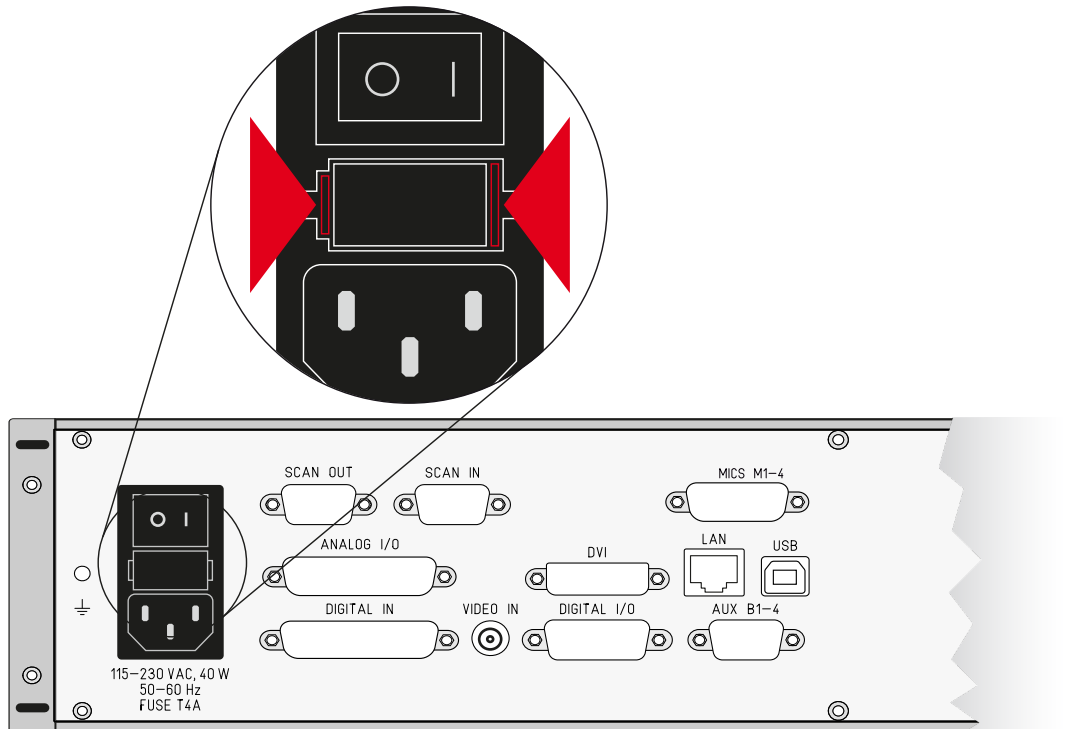

2. Replace the fuse or fuses.

⚠ Only use fuses that match the stipulated ratings!

📖 see „Fuses“ on page 42

3. Push the fuse holder into the slot until the locking tongues snap in.

4 Specifications

Chapter Overview

Purpose This chapter lists the specifications of the TEM Scan Controller Hardware.

Contents This chapter contains the following topics:

- › Operating Conditions 41
- › TEM Scan Controller Hardware Specifications. 42

Operating Conditions

The following table contains information on the operating conditions of the TEM Scan Controller Hardware:

Site of operation	<ul style="list-style-type: none">– indoor– controlled electromagnetic environment
-------------------	---

Ambient air	<ul style="list-style-type: none">– average air pressure (approx. 1 bar)– dry– free of dust
-------------	---

Ambient temperature	5 to 40 °C
---------------------	------------

Humidity	80% max. (at 31 °C, non-condensing)
----------	-------------------------------------

Altitude	2,000 m max.
----------	--------------

TEM Scan Controller Hardware Specifications

Electrical safety The following table contains information on electrical safety:

Protection class	I
Protection type	IP20
Oversvoltage category	II
Contamination level	1

Power supply The following table contains information on the specifications of the power supply:

Supply voltage	115 – 230 VAC
Frequency	50 – 60 Hz
Power draw	40 W max.
Supply voltage fluctuations	± 10% max.

Fuses The following table contains information on the fuses:

Number	2 pc. (replaceable)
Type	T4A
Rating	4 A slow blowing

Dimensions and weight The following table contains information on the dimensions and weights:

Height	90 mm
Width	450 mm
Depth	290 mm
Weight	approx. 4.7 kg

EC-Declaration Of Conformity (Nr 19-2) (V1.1)

according to EC-Directive 2014/30/EC (electromagnetic compatibility) issued 26. 02.2014

For the below given Product is Hereby declared that it conforms to the essential requirements set out in community harmonization legislation:

Electromagnetic Compatibility Directive 2014/30/EU of 14 October 2014

Manufacturer: point electronic GmbH
Erich-Neuß-Weg 15
06120 Halle/Saale
Germany

Declare under sole responsibility for issuing this declaration of conformity in relation to the following product:

Product: digital image scanning system 6th generation
Name: PE-DISS6
Description: digital image acquisition system and active scan control for scanning electron microscopes

It also conforms with the provisions of the following EC directives:

- Low-Voltage-Directive 2014/35/EC issued 26.02. 2014
- RoHS-Directive 2011/65/EC issued 08.06.2011
- Ecodesign-Directive (ERP) 2009/125/EC issued 21.10.2009

The following relevant harmonized standards were applied:

- IEC 61010-1:2010
(Safety requirements for electrical equipment for measurement, control, and laboratory use)
- IEC 61326-1:2012
(Electrical equipment for measurement, control and laboratory use - EMC requirements)

Date/place of issue:
Name of Person:
position in company:

Halle/Saale den 19.12.2019
Christoph Sichtung
Managing Director point electronic GmbH

Unterschrift:



point electronic GmbH
Erich-Neuß-Weg 15
06120 Halle/Germany
Telefon: +49 (0)345 1201190
Telefax: +49 (0)345 1201223
info@pointelectronic.de